

Open Frame - Relay Racks - Knockdown (DNRR Series) - *Light Duty*

Path: [Home](#) > [Rack Index](#) > **Open Frame Relay Racks - Knockdown - *Light Duty* (DNRR Series)**



(click to enlarge)



[Assembly
Instructions](#)

Features:

- Suitable for many 19" rack mount applications (20" wide overall), providing complete access to equipment...
- Easy to assemble...
- Knockdown rack is shipped in a [flat pack container](#) (see below) for easy handling and shipping protection...
- Fabricated in 12-gauge steel or [heavy duty \(10-gauge steel\) version also available...](#)
- Front flange only - is drilled and tapped (10-32) universal EIA (5/8 - 5/8 - 1/2 inch) spacing...
- For use as a single, free standing unit for sturdy support of standard 19" rack mount devices...
- Weight load tested (DNRR1984LDK) to 800 pounds...
- Base is punched to accept four [casters](#) (Part number **1425B, 1425BM or 1425BH**)...
- Finished in rugged black powder paint.

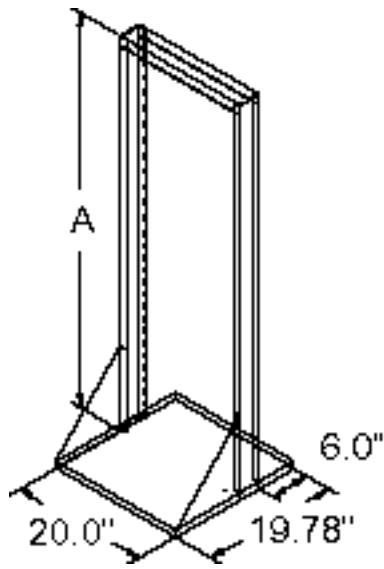

Part Number	Drawing File Size	.zip file size	Panel Height		Overall Dimensions (Inches)		Wt. lbs.
			Inches	Units	Width	A	
DNRR1942LDK	38K	34K	42	24	20	45	38
DNRR1963LDK	44K	40K	63	36	20	66	41
DNRR1970LDK	47K	42K	70	40	20	73	42
DNRR1977LDK	50K	44K	77	44	20	80	45
DNRR1984LDK	49K	46K	84	48	20	87	47



PART No. DNRR1977LDK

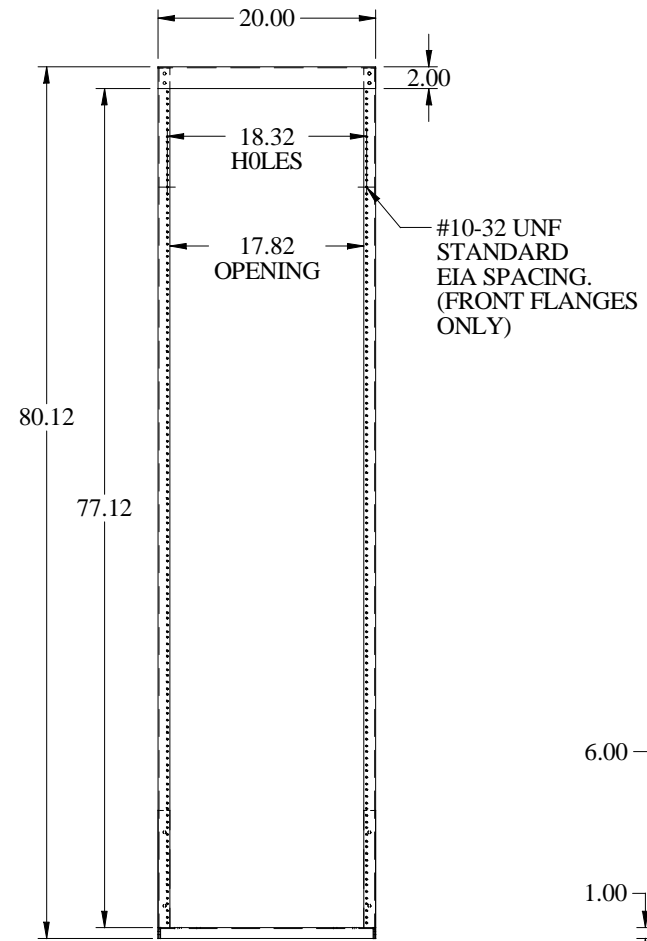
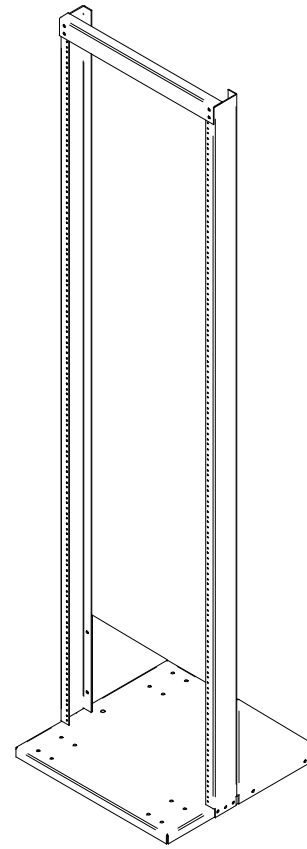

FRONT VIEW

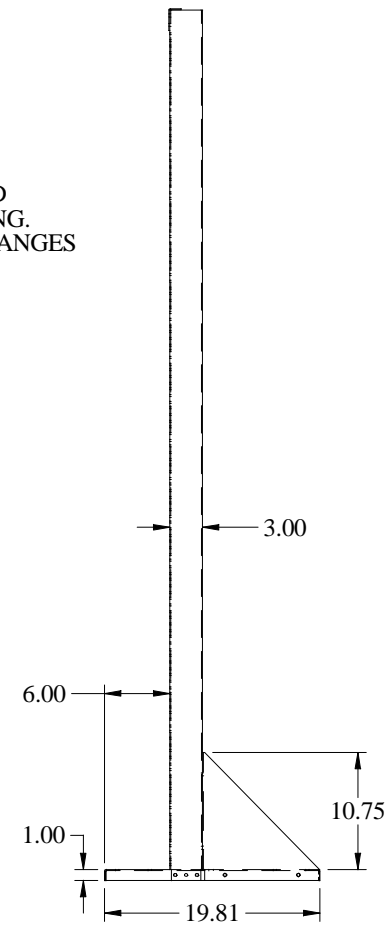

SIDE VIEW

Light Duty - Knockdown (DNRR Series)

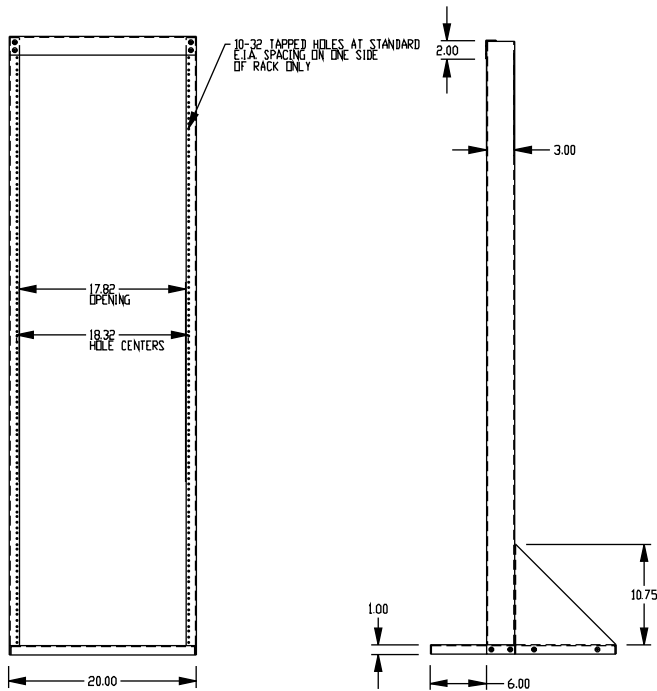

FEATURES

- Suitable for many 19" rack mount applications, providing complete access to equipment
- Easy to assemble
- Knockdown rack is shipped in a flat pack container for easy handling and shipping protection
- 12-gauge steel base & upright channel
- Provides an economical option to an enclosed rack
- Engineered for use as a solid, single, freestanding unit
- Choice of 5 popular heights
- Front flange (ONLY) drilled & tapped rails, 10-32, universal EIA spacing (5/8 - 5/8 -1/2 inch)
- Weight load tested (DNRR1984LDK) to 800 pounds
- Base is punched to accept four casters (Part number 1425B, 1425BM or 1425BH) - see page 121
- Tough textured black powder finish paint

Tapped - Front Flange Only

Part Number	Panel Height		Overall Height (Inches)	Panel Width (Inches)	Hole Thread
	Inches	Units			
DNRR1942LDK	42	24	45	19	10-32
DNRR1963LDK	63	36	66	19	10-32
DNRR1970LDK	70	40	73	19	10-32
DNRR1977LDK	77	44	80	19	10-32
DNRR1984LDK	84	48	87	19	10-32